

For Construction Joints - Hydrotite CJ -

■ Features

Hydrotite CJ-type has been developed as an effective, simple and economical sealing material for site formed construction joints based on the proven effectiveness of Hydrotite.

FEATURES

1. SUPERIOR WATER SEALING

In addition to the packing effect which conventional sealants have, Hydrotite CJ expands as it absorbs water and fills up concrete joint gaps, conforming to the gap variations which ensures excellent sealing.

2. EASY HANDLING AND INSTALLATION

Because Hydrotite CJ is lightweight it is easy to handle and install. There is no need for wire installation, no bending or air-trapping as conventional Waterstops require.



CJ-0725-3K

Conventional Waterstops

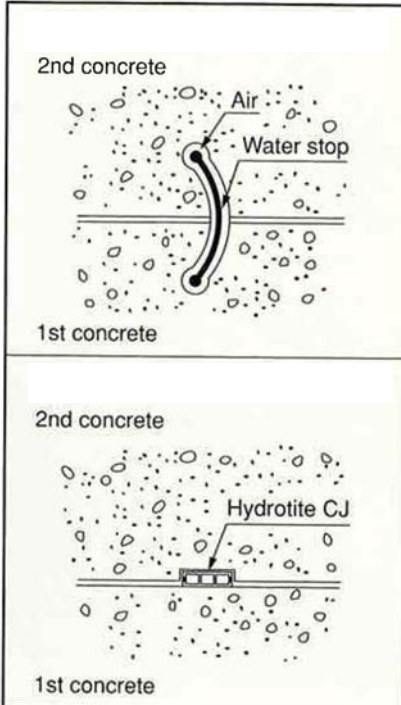

Hydrotite CJ

3. CONTROLLED EXPANSION DIRECTION

Composite structure achieves control on expansion direction.

4. CONTROLLED EXPANSION PRESSURE

The hole(s) in Hydrotite CJ are designed to absorb expansion pressure during the initial stage of expansion and thus avoid the concrete cracking.

5. EXPANSION DELAY COATING

The coating on Hydrotite CJ delays premature expansion by rain or ground water before installation. The delay expansion coating also allows freshly poured concrete to cure.

6. VARIOUS PRODUCT RANGE

Hydrotite CJ comes in a variety of forms, such as CJ-0720-2K, CJ-0725-3K, CJ-1020-2K and CJ-1030-4M.



■ Specifications

STANDARD DIMENSION

The standard dimension and shape of the most popular products CJ-0725-3K is as shown below.



Hydrotite CJ-0725-3K

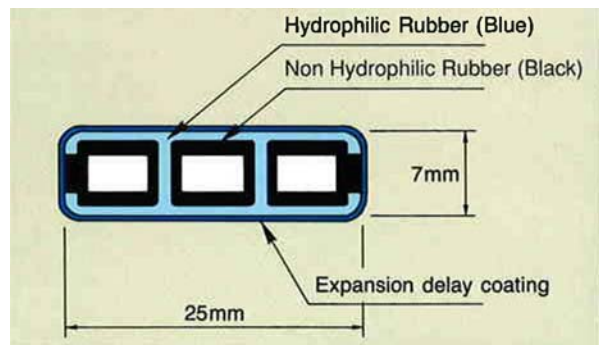

BASIC PHYSICAL PROPERTIES

Table 1. Basic physical properties of Hydrotite

Item	Unit	Hydrophilic Rubber		Non-hydrophilic Rubber	
		Standard	Typical	Standard	Typical
Specific gravity	-	1.40±0.10	1.35	1.40±0.10	1.41
Hardness	(JIS, SPRING A)	50±5	52	50±5	51
Tensile strength	kgf/cm ²	Min.30	37	Min.90	125
	N/mm ²	Min.2.94	3.63	Min.8.82	12.25
Elongation	% ²	Min.600	760	Min.400	435

SWELLING CHARACTERISTICS

Swelling characteristics of Hydrotite CJ depend in the water quality as typical examples shown below.

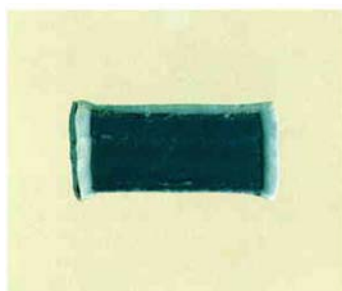
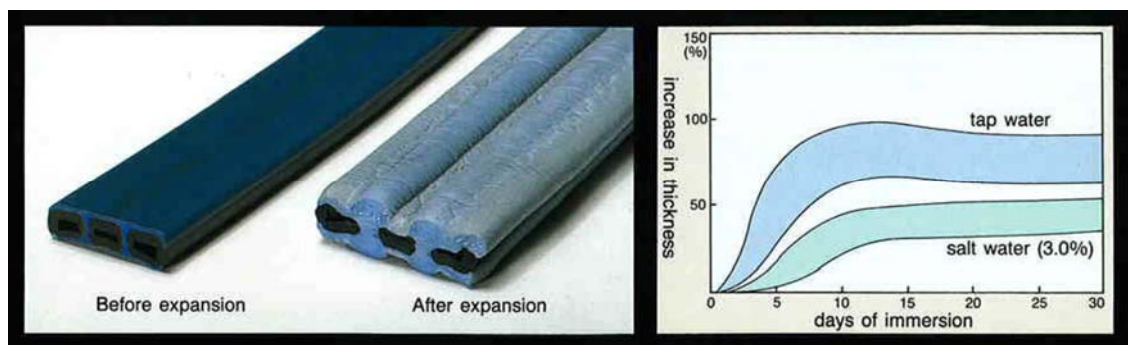

1 day immersion

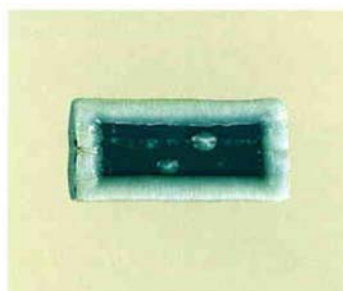

3 days immersion

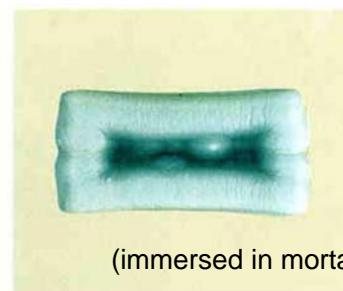

10 days immersion

(immersed in mortar water)

(Note) Hydrotite CJ starts to swell from its edges/corners partially and continues to swell gradually overall.

WATER SEALING PROPERTY

(Test Method)

(1)The test specimens are bonded to the 1st site formed concrete, and then the 2nd concrete is cast on the 1st concrete.

(2)After removing the forms, the 1st concrete and the 2nd concrete are secured by bolts.

(3)The jig is filled with water for checking the leakage by increasing the water pressure in 1.0kgf/cm² stages after jig has been sealed for at least 10 minutes.

(4)The number of days required for sealing water is thus recorded for a specific gap.

(5)After insuring no leakage, the gap is increased in 1.0mm stages. Then this procedure is repeated up to a 2.0mm gap.

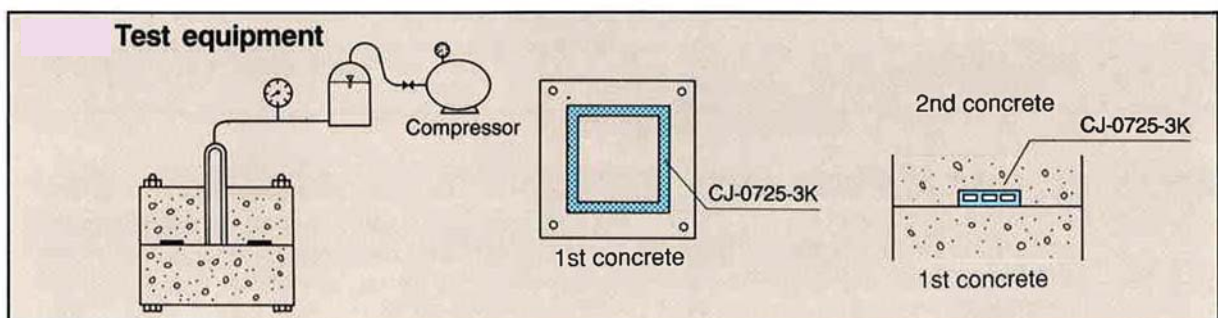
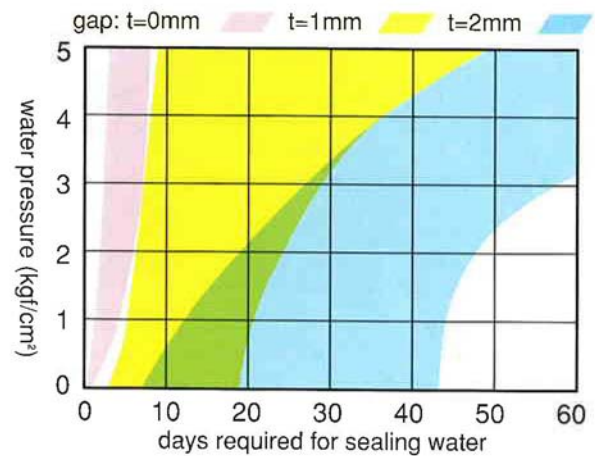

Warranty

All statements regarding this product are based upon procedures and tests which we believe are reliable, and may be changed for improvement of quality without any notice; but it will be the sole responsibility of the customer and/or end user to use this product properly, and therefore assume all risk and liability in connection therewith.

C. I. Kasei Co., Ltd. Warrants its products to be of good quality and will replace product proved to be defective. In no instance will C. I. Kasei Co., Ltd. be liable for labor costs or incidental damage associated with the use of this product, unless stated in a warranty for a specific project.

Application

1. Wall joints

Position CJ centrally or towards either edge if preferred.

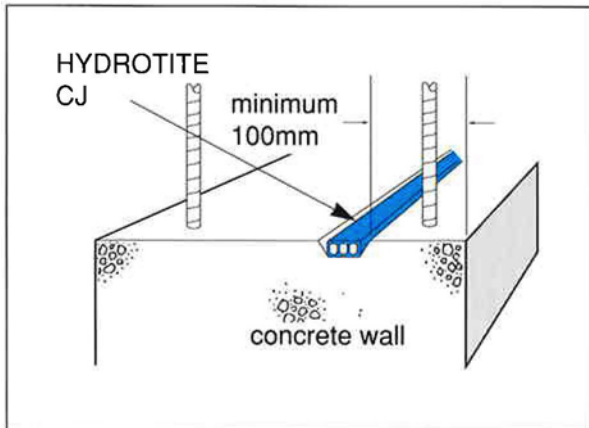

2. Joints of lining concrete for NATM Tunnel & Shield Tunnel

N.A.T.M. (New Austrian Tunneling Method)

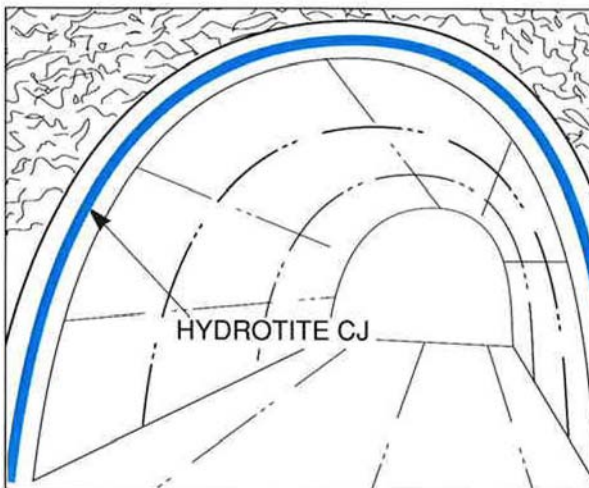

3. Pipes passing through concrete

Position CJ around pipes and other fittings passing through concrete.

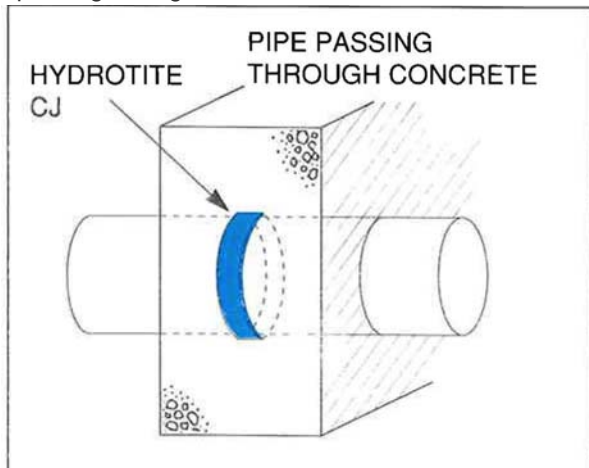

4. Slab joints

Position CJ centrally or towards either edge if preferred.

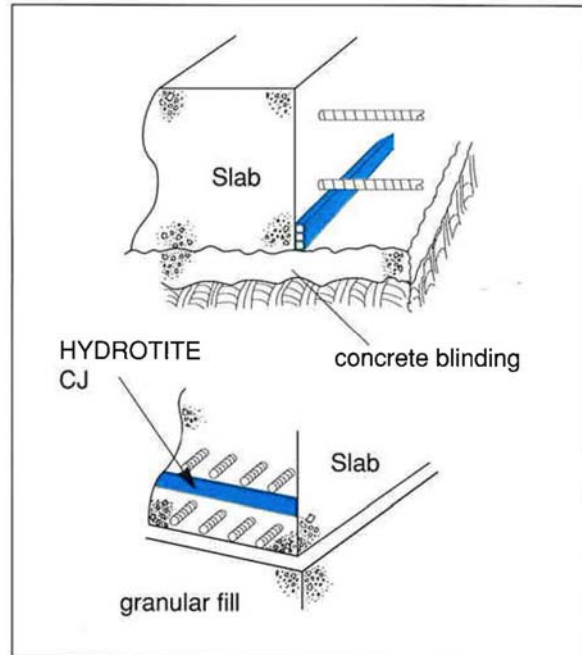

5. Precast concrete joints

(Box culvert, precast concrete panels)

Profile thicker than the design gap dimension should be selected from the profile list for best results.

Adhere CJ to the groove with Neoprene adhesive continuously.

Precast concrete panels should be connected with bolts each other.

